

Vacuum micromanipulator

Vacuum micromanipulator

- Professional vacuum system for precise handling of tiny SMD components and silicon wafers
- Suitable for assembly and laboratory work

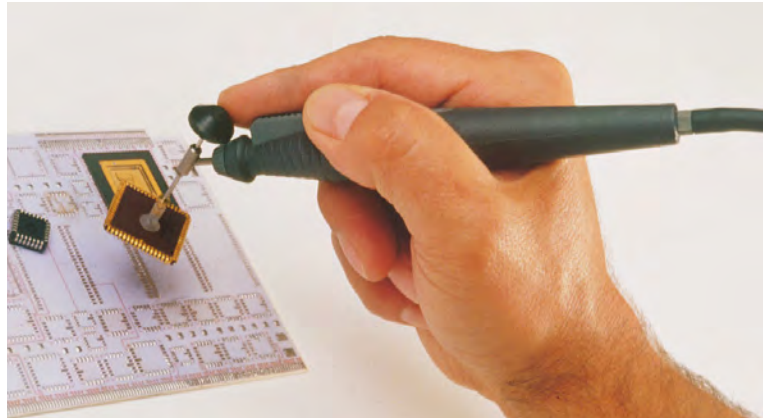

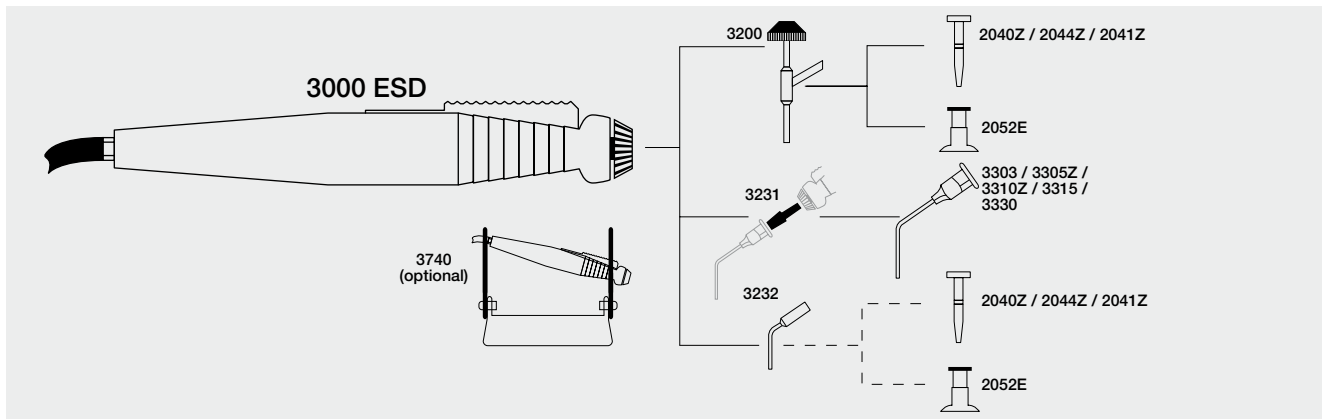

Advantages of the vacuum micromanipulator:

- Easy picking up of components or silicone wafers
- Immediate set-down/release of parts
- Full 360° rotating system
- Direct axial switch for vacuum
- Ergonomic shape reduces hand and wrist fatigue
- ESD-safe



Handle



 **140 mm/5.512 Inch**
 **35 g/1.23 oz.**

- Ergonomic handle with axial switch, serrated finger grip for secure handling.

Model

Dimensions in mm/Inch

3000ESD*

Dia. 10 mm
.394 Inch

Handle

*Not available in North America



Inserts for 3000ESD housing

Adapters

Model			Description	
3200*		25 mm .984 Inch	15 g 0.53 oz.	Stainless-steel adapter, rotatable through 360°, straight suction tip for direct working or as an adapter for suction tips or suction cups
3231*		5 mm .197 Inch	5 g 0.17 oz.	Adapter fix, for working with Series 3300 suction tips
3232*		15 mm total .590 Inch	3 g 0.10 oz.	Adapter fix, for direct working or as an adapter for suction tips 20442/20412 or suction cup 2052E

Suction tips, straight

- Polyethylene suction tip.
- For working with 3200 or 3232 adapter.

Model		Outside diameter	Inside diameter
2044Z*		1.3 mm .051 Inch	0.9 mm .035 Inch
2041Z*		2.0 mm .078 Inch	1.4 mm .015 Inch

*Not available in North America

Vacuum micromanipulator

Inserts for 3000ESD housing

Suction needles

- Stainless-steel suction needle.
- Bent 45°.
- For working with 3200 or 3232 adapter.

Model		Outside diameter	Inside diameter
3303*		0.30 mm .011 Inch	0.16 mm .006 Inch
3305Z*		0.50 mm .020 Inch	0.25 mm .019 Inch
3310Z*		1.0 mm .039 Inch	0.65 mm .025 Inch

Suction cups

- Silicone suction cup.
- For working with 3200 or 3232 adapter.

Model		Diameter
2052E*		4.5 mm .177 Inch

*Not available in North America

Inserts for 3000ESD housing

Accessories

Model	Description
3714Z*	Diaphragm pump 230 V, 5 l/min, max. vacuum -250 mbar
3008ESD*	Tube, flexible, 1.8 m/70.866 Inch, ESD-safe
3717*	Filter for tube 3008ESD
3740*	Table holder for 3000ESD (without accessories)

Vacuum kit



- Complete accessories for easy pick-up and immediate set-down of components or silicon wafers.
- Set for laboratory work.
- In an ESD-safe plastic case.

Model	Description
3000KCESD*	Vacuum kit
	contents:
3000ESD	Handle
3200	Adapter, rotatable through 360°
3231	Adapter fix
3305Z, 3310Z, 3315	Suction needles
2052E	Suction cup, dia. 4.5 mm / .177 Inch
KDS 260L	Suction cup, dia. 9.5 mm / .374 Inch
3740	Table holder
3714Z	Diaphragm pump 230 V
3008ESD	Tube, flexible
3717	Filter
102ACA	SMD tweezers, 115 mm / 4.527 Inch, with bent tips and blunted edges. For vertical working with small components. Stainless steel, non-reflecting surface, non-magnetic.

*Not available in North America